

MaxMotion

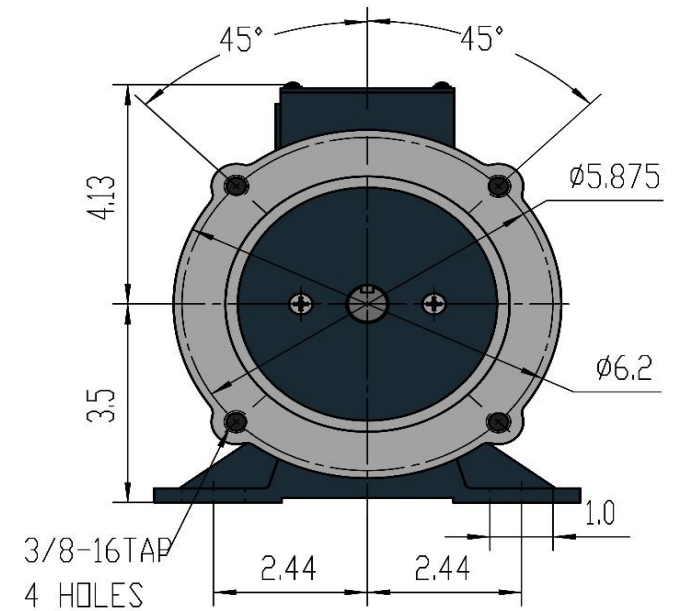
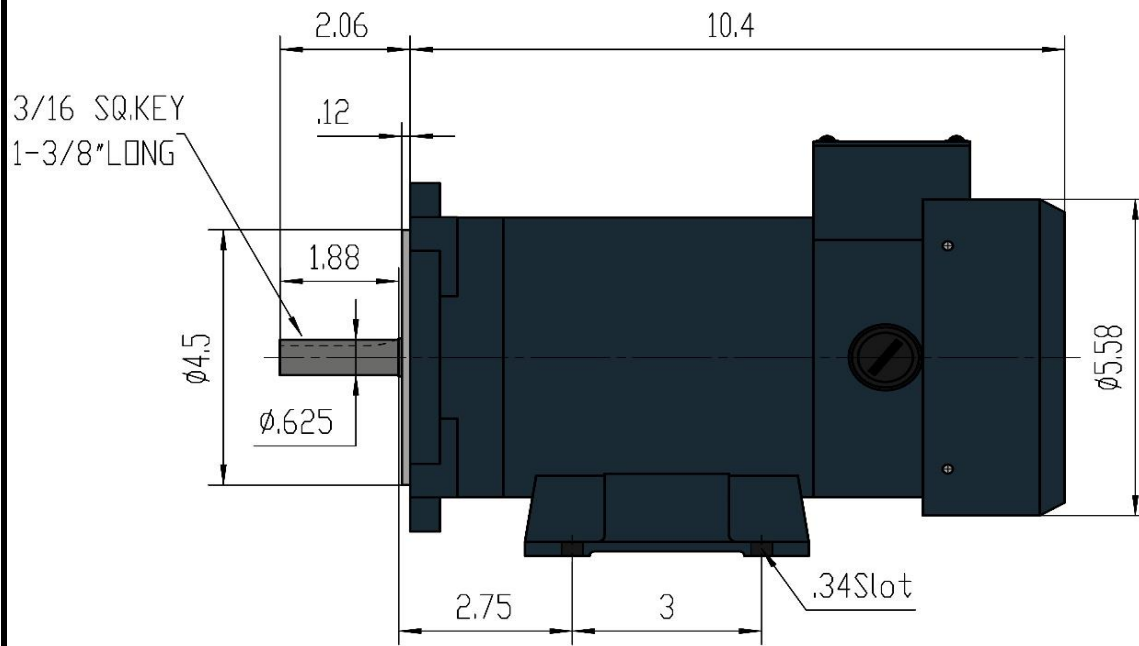

Customer is responsible in determining that MaxMotion product will fit/perform suitably in the intended application

Version: 1NIN

Revised: April 2020

HP	RPM	Voltage	Amps	Const.	Frame	Insul.	Torque	P. Code	Wgt lbs	Rated
0,5	1750	90Vdc	6,28	TEFC	56C	Class H	18 in/lbs	K (SCR)	25	IP45

MM5090FC